

**NOTES**

1. All dimensions are in millimetres unless otherwise stated.

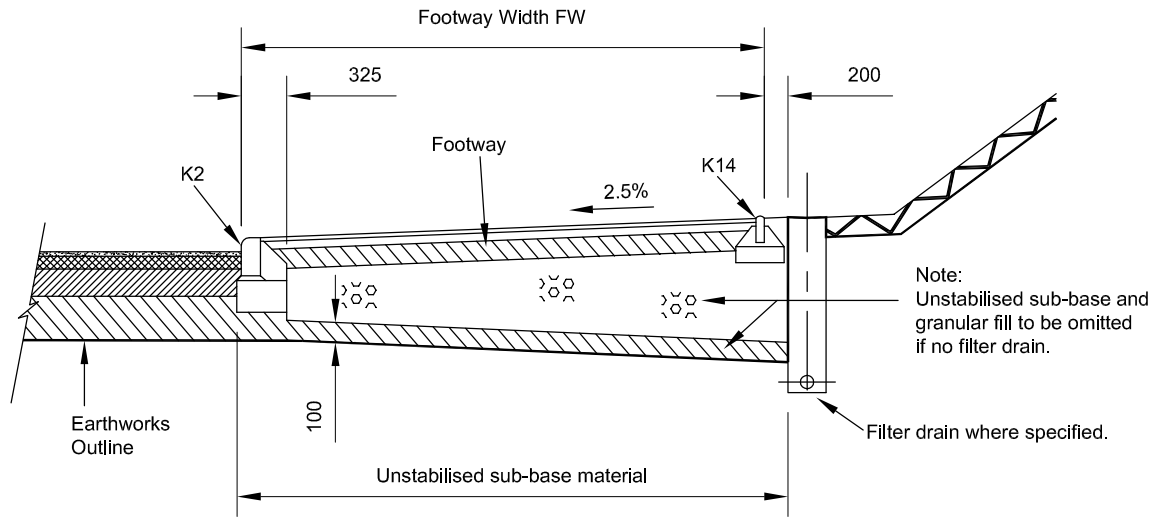

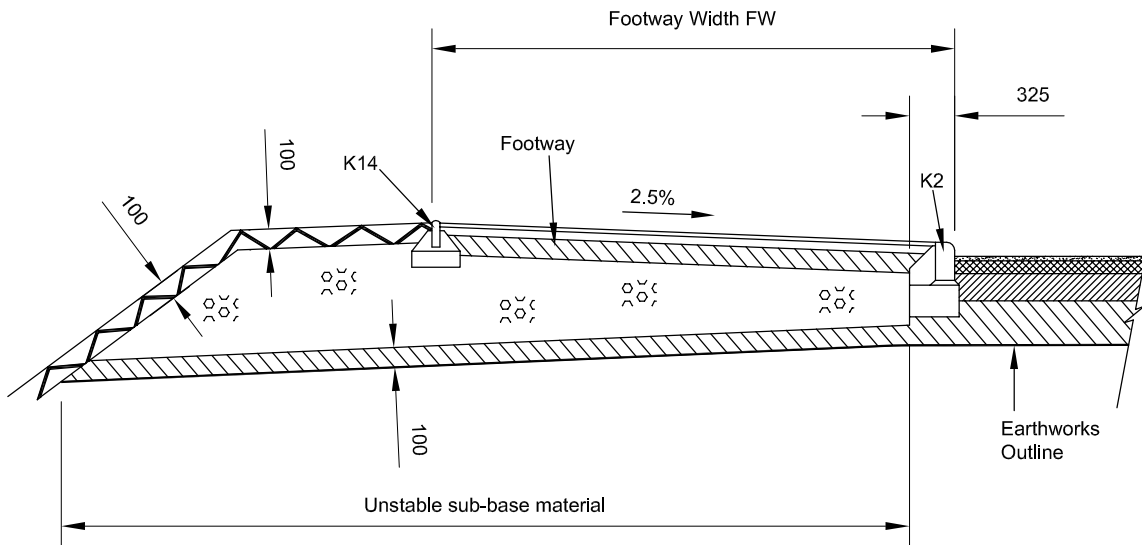





**CUTTING**



**EMBANKMENT**

**KEY**

-  surface course
-  binder course
-  base
-  Sub-base
-  Granular fill class 1
-  Topsoil

| No. | Date | Description |
|-----|------|-------------|
|     |      | AMENDMENTS  |